

For Information on Focal Probe fixturing, see page 107.

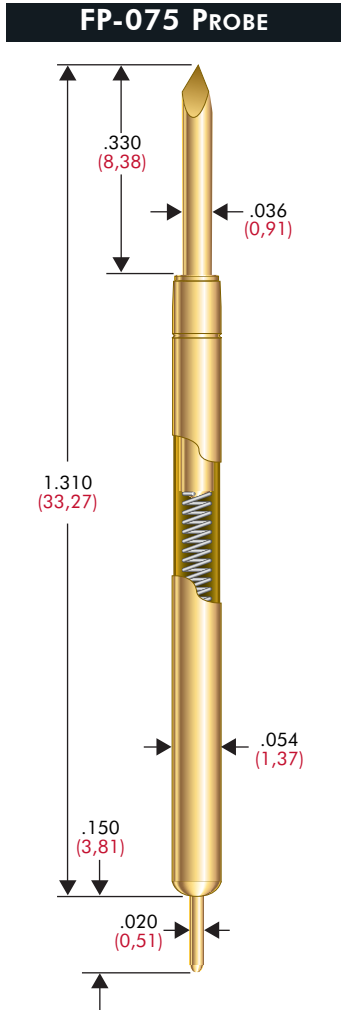

PROBE SPECIFICATIONS

Minimum Centers: .075 (1,91)
Current Rating: 3 amps continuous
Spring Force: 3.5, 5.5, 6.7, 8.0 or 10 oz. @ .170 (4,32) travel
Typical Resistance: <25 mΩ
Maximum Travel: .250 (6,35)
Working Travel: .170 (4,32)

Rated Force oz (gms)	Preload oz (gms)	Material
3.5 (99)	1.5 (43)	BeCu
5.5 (156)	2.4 (68)	MW
6.7 (190)	2.8 (80)	SS
8.0 (227)	3.3 (94)	MW
10.0 (283)	3.7 (105)	MW

MATERIALS

Barrel: Nickel/silver, gold plated
Spring: Music wire, nickel plated, stainless steel or beryllium copper, precious metal plated
Plunger: Full-hard beryllium copper or steel, gold over nickel plated
Receptacle: Nickel/silver, gold plated
FP-Plug: Nickel/silver, gold plated

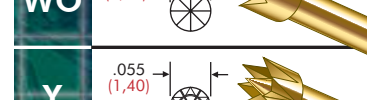
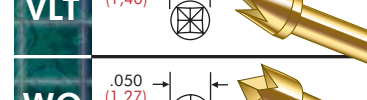
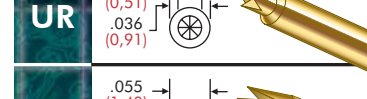
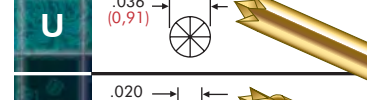
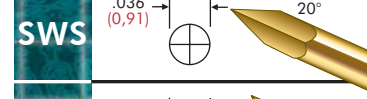
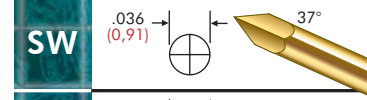
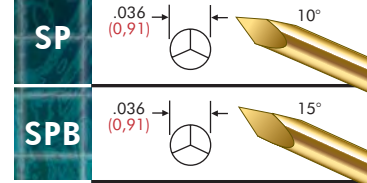
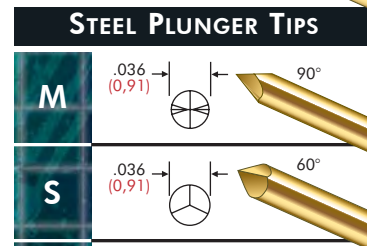
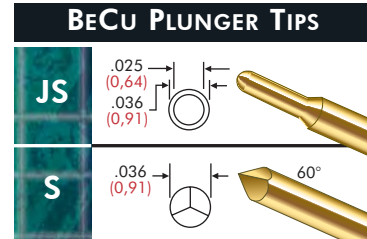

RECEPTACLE OPTIONS

Part Number	Style	Receptacle Length	Probe/Receptacle Combined Length	Comments
R-00-W-390	Receptacle	.390 (9,91)	1.700 (43,18)	
R-00-W-500	Receptacle	.500 (12,70)	1.810 (45,97)	
FP-Plug	Plug-in Terminal	.285 (7,24)	*	30 or 28 gage wire
R-0-WW-390	Wire Wrap	.640 (16,26)	1.950 (49,53)	.250 post length - .016 sq.
R-0-WW-500	Wire Wrap	.750 (19,05)	2.060 (52,32)	.250 post length - .016 sq.

* FP-Plug adds an additional .115 (2,92) to the Probe/Receptacle combined length.

HOW TO ORDER: SPRING CONTACT PROBE RECEPTACLE

FP SERIES	075 SIZE	SP TIP STYLE	5.5 SPRING FORCE	G PLATING OPTION	S STEEL PLUNGER OPTION	R SERIES	00 SIZE	W TERMINATION	390 LENGTH
<p>SPRING FORCE: 3.5 oz. @ .170 (4,32) travel 5.5 oz. @ .170 (4,32) travel 6.7 oz. @ .170 (4,32) travel 8.0 oz. @ .170 (4,32) travel 10.0 oz. @ .170 (4,32) travel</p> <p>CRIMPING PLIERS: CPWT CP00W-390 CP00W-500</p> <p>INSERTION TOOL: RT00 PLUG-IN TOOL: RTWT</p>						<p>TERMINATIONS: W: Receptacle* WW: Wire Wrap FP-Plug: Plug-in Terminal*</p> <p>* To order with preattached wire, add wire length and strip length (in inches) to the end of the part number. For example: R-00-W-390-36-1 or FP-PLUG-36-1</p> <p>LENGTH: 390 or 500</p>			

View updates of this information at www.idinet.com

Specifications subject to change without notice. Dimensions in inches (millimeters)